



FEATURES:

- Ultra-wide Input Range: 100~347 VAC
- High Efficiency: Up to 86%
- Active Power Factor Correction
- Short Circuit / Over Voltage Protection
- Design to meet UL Class 2 and Class P
- Long Life, High reliability
- Ultra-low ripple without flickering
- 5-year limited warranty

Models
Single output



Model	Max Output Power (W)	Output Voltage Range (V)	Output Current (mA)	Input Voltage (VAC/Hz)	Efficiency (%)	
					115VAC	230/277 VAC
AMEHR50-4270Z	30	24-42	700	90-385/47-63	87	86
AMEHR50-4285Z	36	24-42	850	90-385/47-63	86.5	86.5
AMEHR50-42100Z	40	24-42	1000	90-385/47-63	86	86.5
AMEHR50-42120Z	50	24-42	1200	90-385/47-63	85.5	87

NOTE: All specifications in this datasheet are measured at an ambient temperature of 25°C, humidity <75%, nominal input voltage and at rated output load unless otherwise specified.

Input Specifications

Parameters	Conditions	Typical	Maximum	Units
Input Current	90/176 VAC, full load		0.35/0.18	Arms
			0.45/0.23	
			0.5/0.25	
			0.6/0.3	
Inrush current	230 VAC, cold start, T<2mS at 50 I _{PEAK}		60	A
Leakage current	277VAC		0.75	mA
Input dissipation	Full Input Range, No Load		1.8	W
	Output Short		3	
Power Factor	115 VAC, full load, CV≥36V	0.99		
	230 VAC, full load, CV≥36V	0.97		
	277 VAC, full load, CV≥36V	0.92		
	347 VAC, full load, CV≥36V	0.89		
THD	115 VAC, full load, CV≥36V	10	15	%
	230 VAC, full load, CV≥36V	12	20	
	277 VAC, full load, CV≥36V	12	20	
	347 VAC, full load, CV≥36V	15	20	
Input Fuse	Recommended Slow Blow Type		2	A
Start-up Time	230 VAC, full load		1.3	Sec.

Output Specifications

Parameters	Conditions	Typical	Maximum	Units
Current accuracy	Full Range	±5		%
Line regulation	LL to HL	±1		%
Load regulation	Full Input Voltage Range	±1		%
Ripple & Noise	Output voltage at 36V		360	mV p-p
Output Current Ripple	Full load		60	mA
Minimum Load Voltage	See Models Table Above			

NOTE: Ripple and Noise are measured at 20MHz bandwidth & 230VAC by using a 0.1µF (M/C) and 10µF (E/C) parallel capacitor.

Isolation Specifications

Parameters	Conditions	Typical	Rated	Units
Tested I/O voltage	<5mA, 60s		3750	VAC
Isolation Resistance	500Vdc	>100		MΩ

General Specifications

Parameters	Conditions	Typical	Maximum	Units
Switching frequency			150	KHz
Over voltage protection		47.5	50	V
Short circuit protection		Continuous, Hiccup Mode		
Short circuit restart		Auto Recovery		
Operating temperature	Without Derating	-40 to +50		°C
Maximum case temperature	Maximum	80		°C
	5 Years Warranty	60		
Storage temperature		-40 to +85		°C
Temperature coefficient			0.05	% / °C
Cooling		Free Air Convection		
Humidity			90	% RH
Case material		Metal		
IP Rating		IP20		
Weight		520		g
Dimensions (L X W X H)		6.30 x 1.73 x 1.61 inches	210.00 x 86.00 x 41.00 mm	
MTBF		>450,000 hrs (MIL-HDBK-217F at +25°C)		

Safety Specifications

Parameters		
Agency Approval	Design to meet UL Class II and Class P	
Standards	Electromagnetic Interference	EN55015 / FCC Part 15, Class B
	Harmonic Current Emissions	EN61000-3-2, Class B
	Voltage fluctuations and flicker	EN61000-3-3
	Electrostatic Discharge Immunity	EN61000-4-2, 8kV Air, 4kV Contact, Level 3, Criteria A
	RF, Electromagnetic Field Immunity	EN61000-4-3, Test-RS Level 3, Criteria A
	Electrical Fast Transient / Burst Immunity	EN61000-4-4, Burst EFT Level 3, Criteria A
	Surge Immunity	EN61000-4-5, Line to Neutral 2kV, Neutral to FG 4kV
	RF, Conducted Disturbance Immunity	EN61000-4-6, Test-CS Level 3, Criteria A
	Power frequency Magnetic Field Immunity	EN61000-4-8, Test 3A/m, Criteria A
	Voltage dips, Short Interruptions Immunity	EN61000-4-11, Criteria B
	Electromagnetic Immunity Requirements Applies to Lighting Equipment	EN61547-2000

Typical Application diagram

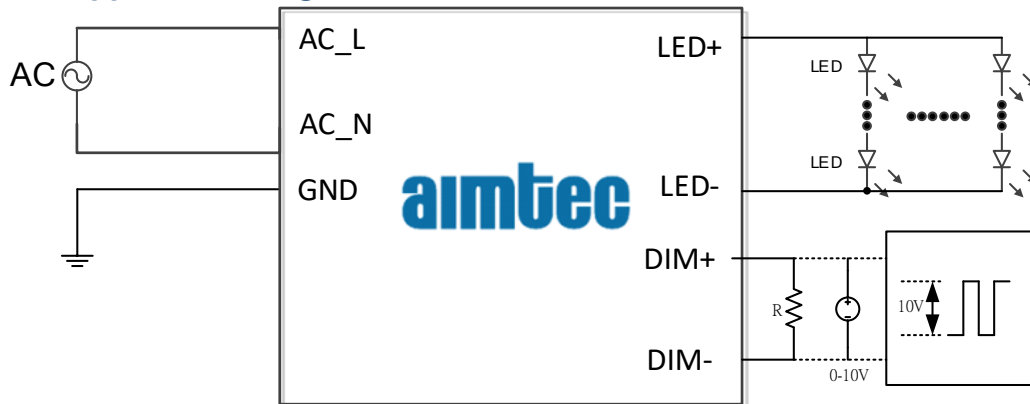

Pin Definition

Terminal	Specification / Termination
AC-N	Input terminal, Connect to Neutral, Recommended Wire Gauge #20-24
AC-L	Input terminal, Connect to Line, Recommended Wire Gauge #20-24
GND	Input terminal, Connect to Earth Ground, Recommended Wire Gauge #20-24
LED+	Output terminal, Connect to positive pole of LEDs, Recommended Wire Gauge #14-26
LED-	Output terminal, Connect to negative pole of LEDs, Recommended Wire Gauge #14-26
DIM+	Input terminal, Connect to positive pole of Dimming, Recommended Wire Gauge #14-26
DIM-	Input terminal, Connect to negative pole of Dimming, Recommended Wire Gauge #14-26

Reference Wiring Diagram

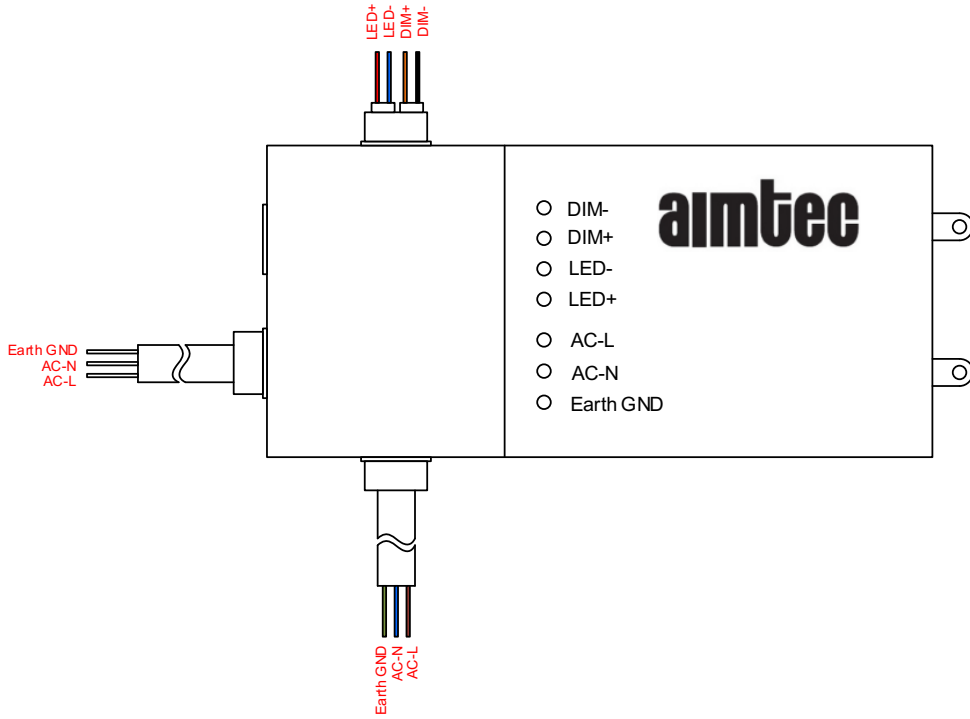

Wire Connection Diagram

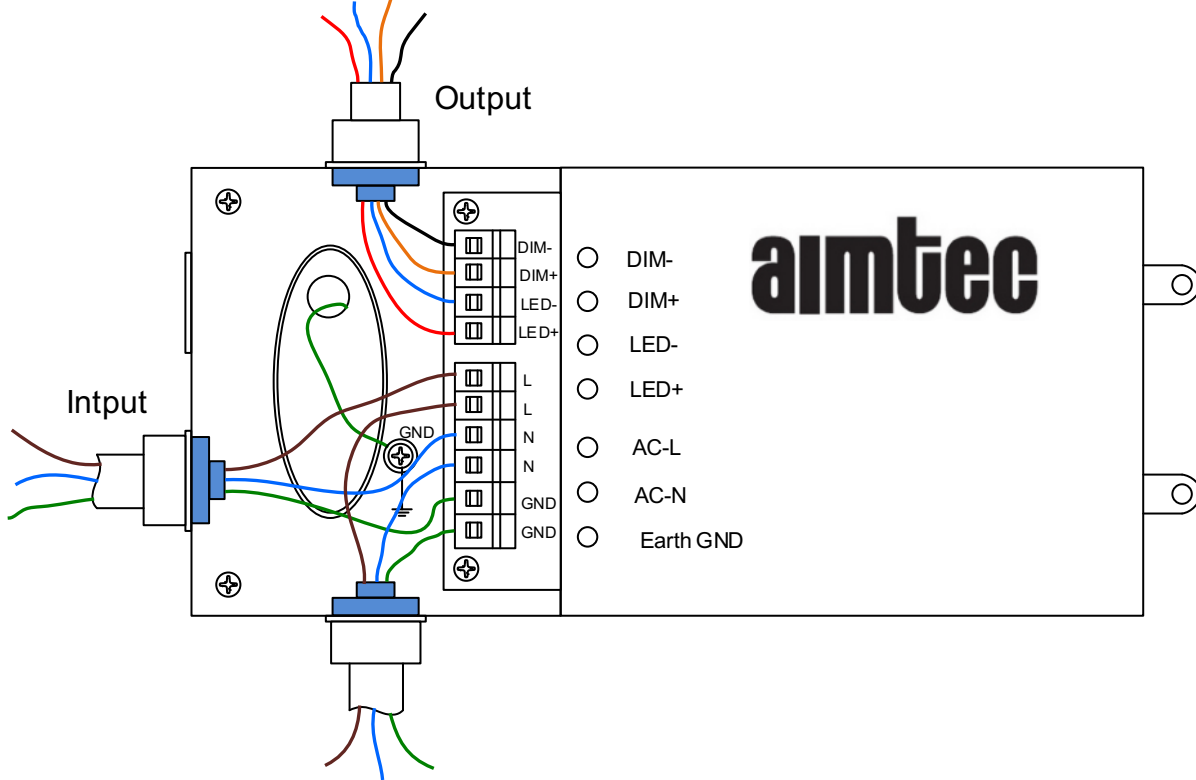

Dimensions

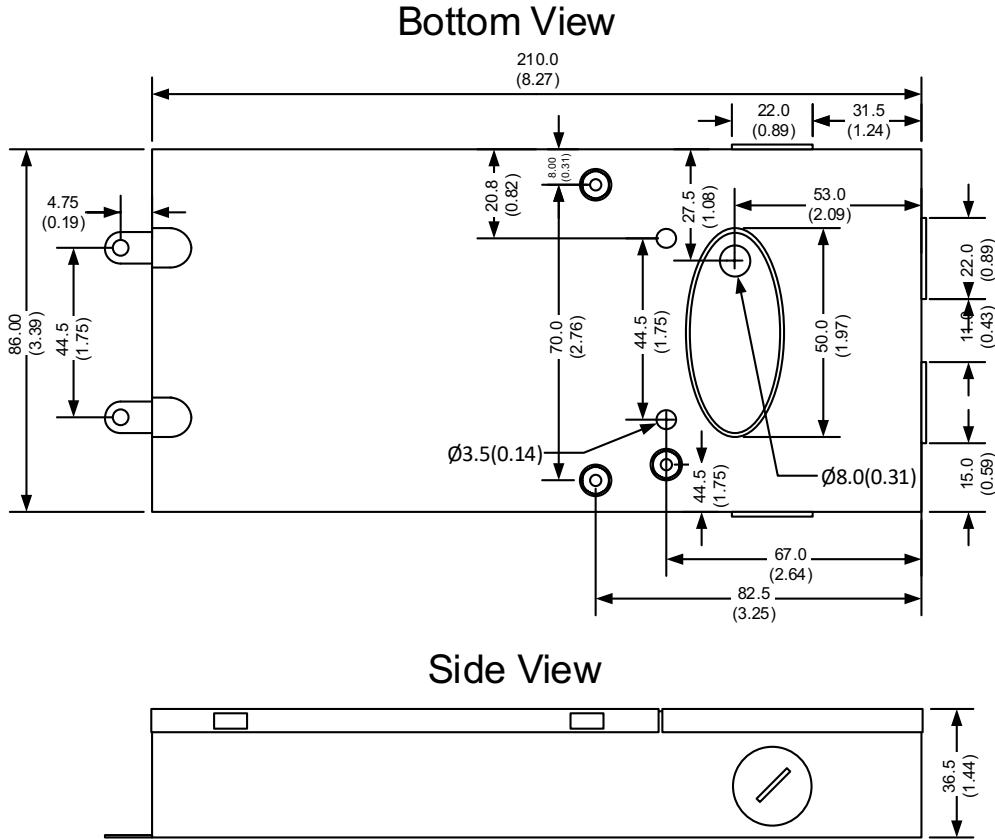

Efficiency Vs. Input Voltage & Output Load Voltage

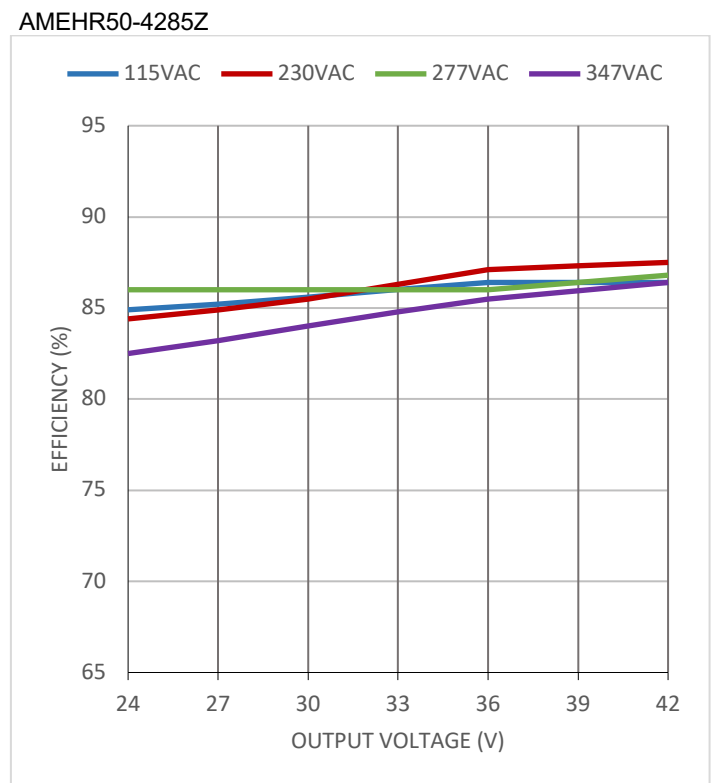
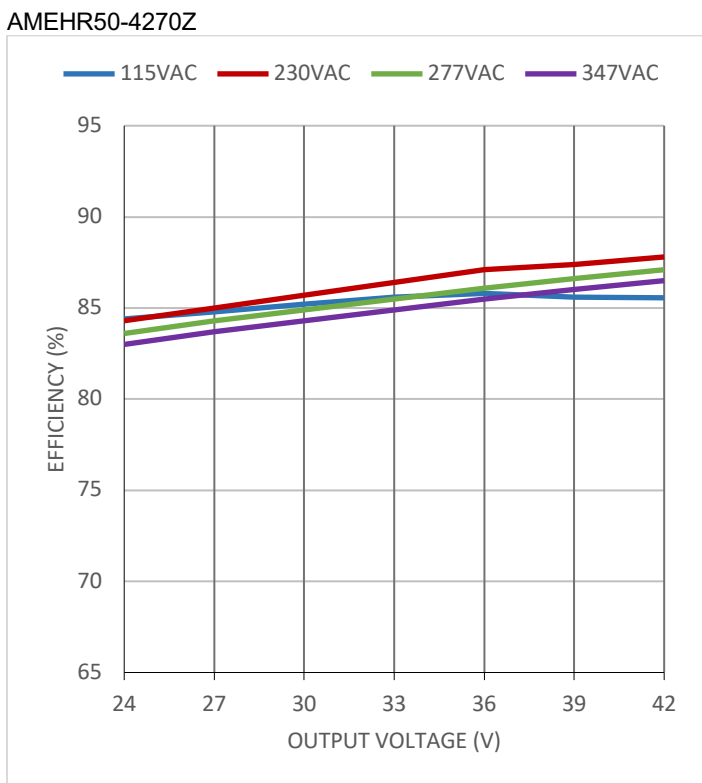

AMEHR50-42100Z

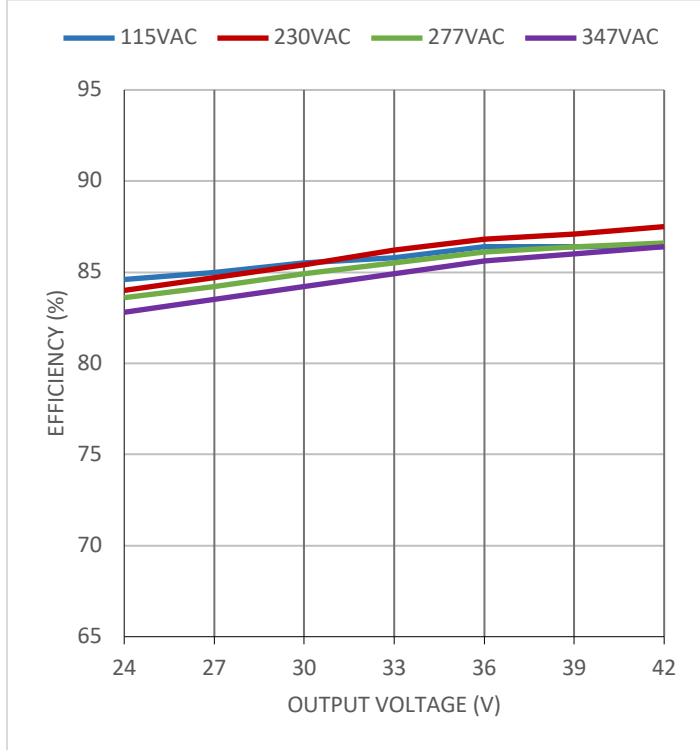

AMEHR50-42120Z

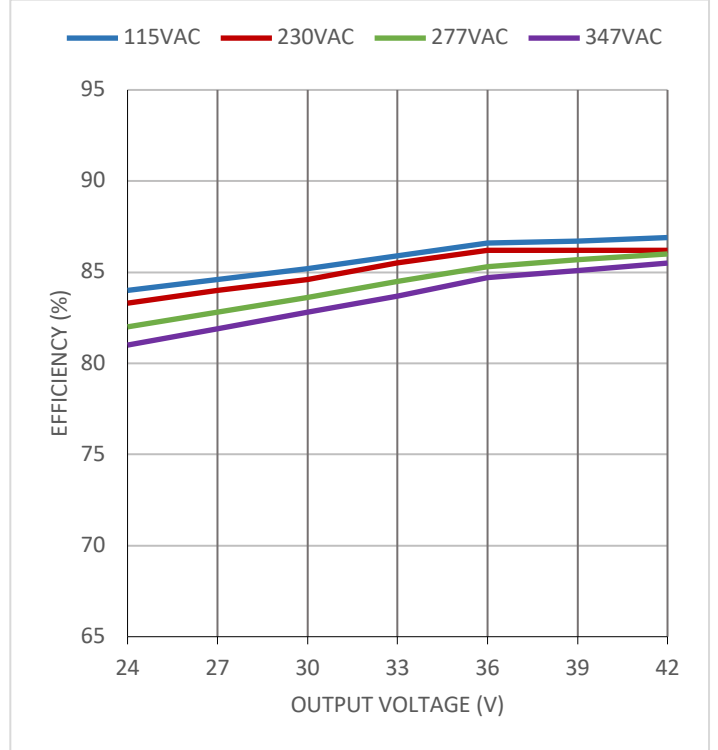

PF vs. Input Voltage & Output Load Voltage

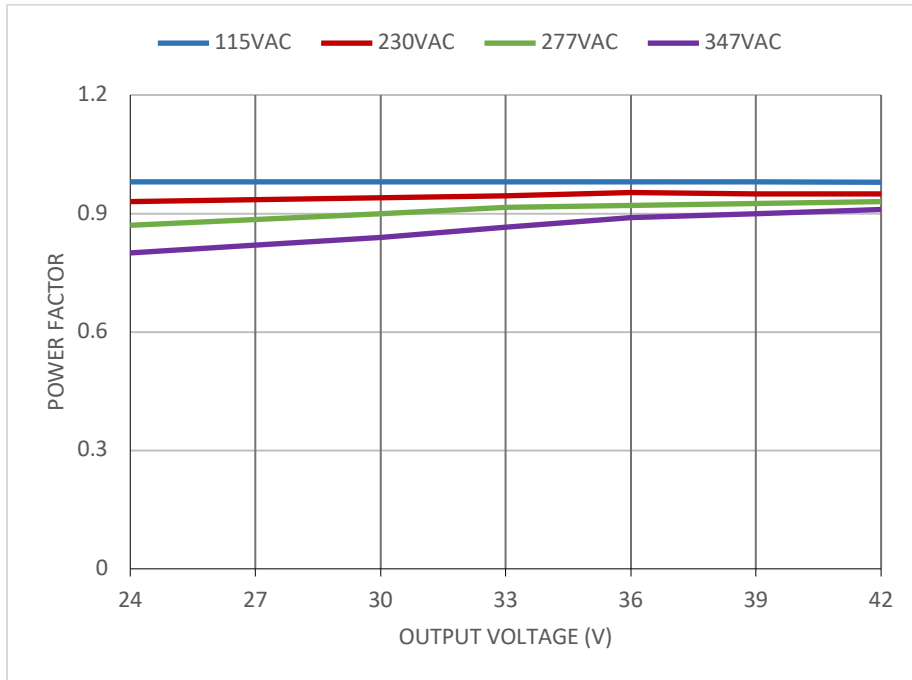

Dimming Graph

Dimming Resistance/Voltage vs Rated Output Current

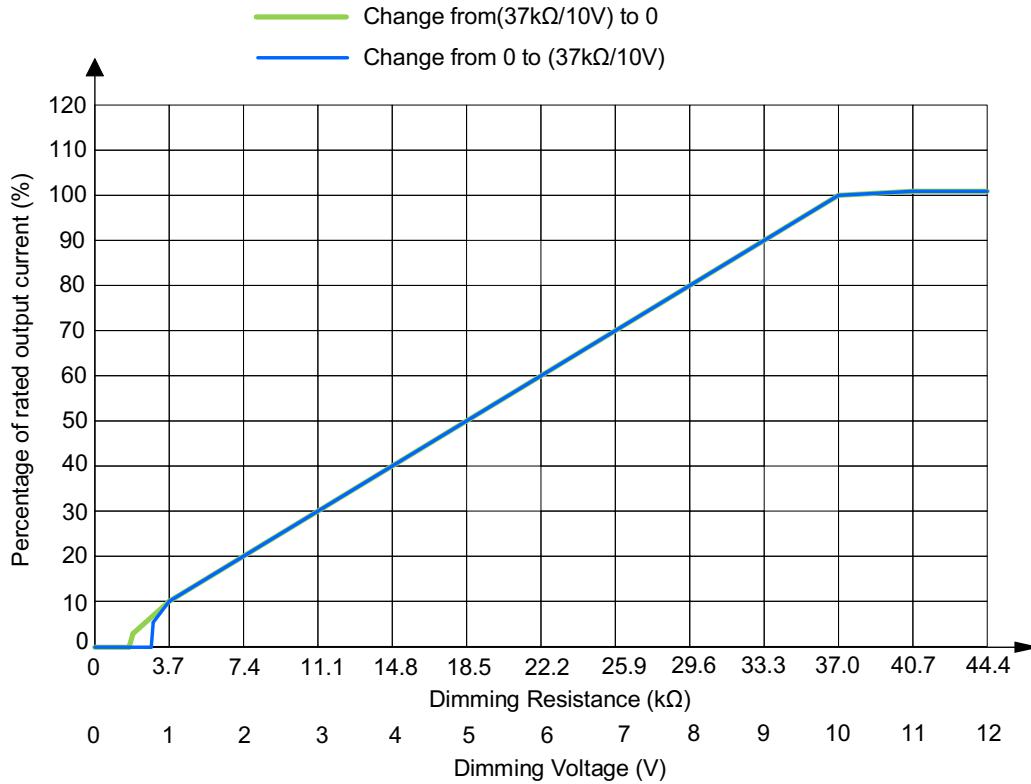

Dimming PWM vs Rated Output Current

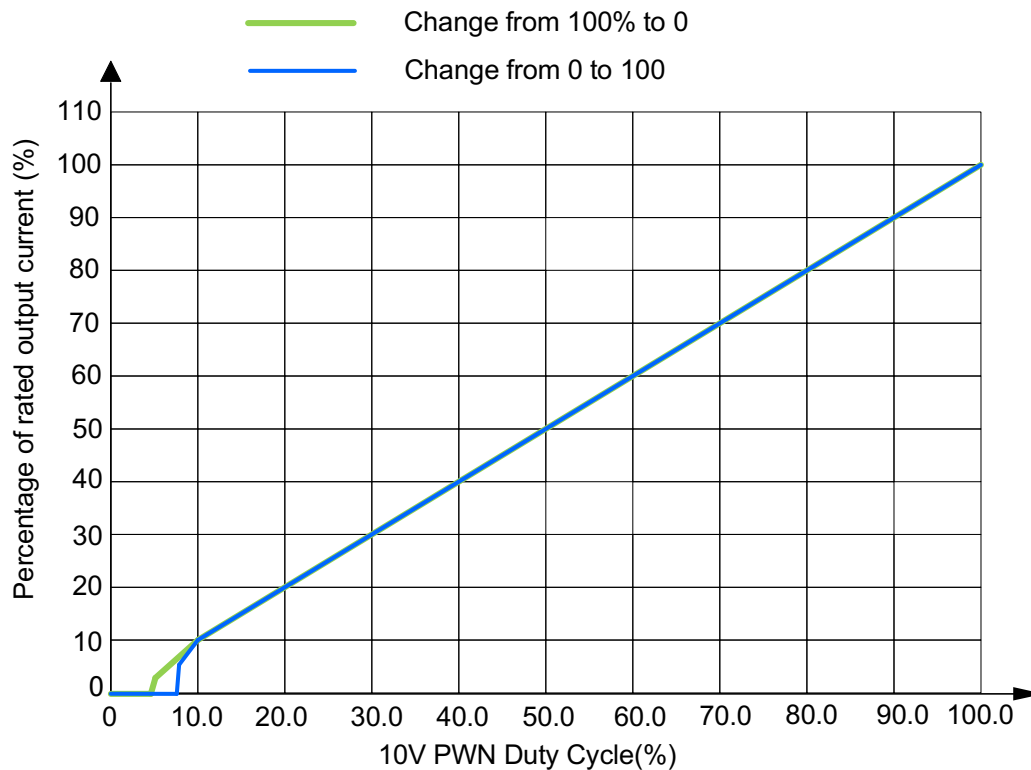

Dimming Control Application

Resistance reference table

Resistance Value (KΩ)	3.7	7.4	11.1	14.8	18.5	22.2	25.9	29.6	33.3	37.0	OPEN
Rated Current (%)	10	20	30	40	50	60	70	80	90	100	95~105

DC voltage reference table

Voltage (V)	0	0.8	1.0	2.0	3.0	4.0	5.0	6.0	7.0	8.0	9.0	10.0	OPEN
Rated Current (%)	0	9	10	20	30	40	50	60	70	80	90	100	95~105

PWM value reference table

Duty Cycle Ratio (%)	10	20	30	40	50	60	70	80	90	100	OPEN
Rated Current (%)	10	20	30	40	50	60	70	80	90	100	95~105

NOTE: **1.** Datasheets are updated as needed and as such, specifications are subject to change without notice. Once printed or downloaded, datasheets are no longer controlled by Aimtec; refer to www.aimtec.com for the most current product specifications. **2.** Product labels shown, including safety agency certifications on labels, may vary based on the date manufactured. **3.** Mechanical drawings and specifications are for reference only. **4.** All specifications are measured at an ambient temperature of 25°C, humidity<75%, nominal input voltage and at rated output load unless otherwise specified. **5.** Aimtec may not have conducted destructive testing or chemical analysis on all internal components and chemicals at the time of publishing this document. CAS numbers and other limited information are considered proprietary and may not be available for release. **6.** This product is not designed for use in critical life support systems, equipment used in hazardous environments, nuclear control systems or other such applications which necessitate specific safety and regulatory standards other the ones listed in this datasheet. **7.** Warranty is in accordance with Aimtec's standard Terms of Sale available at www.aimtec.com