



FEATURES:

- Short Circuit Protection
- Thermal Shutdown
- Non-Isolated
- Low ripple and noise
- Pin Compatible to LM78xx
- Operating temperature -40°C to +85°C
- Very high efficiency up to 93%
- Ultra-low no load power consumption
- Regulated Outputs



Models Single output

Model	Input Voltage Nom/Range (V)	Output Voltage (V)	Output Current max (mA)	Efficiency Vin Min (%)	Efficiency Vin Max (%)	Max. Capacitive load (µF)
AMSRI-783.3-NZ	24 / 4.75-36	3.3	500	78	81	680
AMSRI-7805-NZ	24 / 6.5-36	5	500	82	85	680
	12 / 7-31	-5	-300	78	81	330
AMSRI-7809-NZ	24 / 12-36	9	500	87	90	680
AMSRI-7812-NZ	24 / 15-36	12	500	89	92	680
	12 / 8-24	-12	-150	82	85	330
AMSRI-7815-NZ	24 / 19-36	15	500	90	93	680
	12 / 8-21	-15	-150	82	85	330

Note: For higher than 30VDC input, adding 22µF/50V capacitor required.

Input Specifications

Parameters	Conditions	Typical	Maximum	Units
Voltage range	See the table above			VDC
Filter	Capacitor			
Quiescent current	Vin=(LL-HL) at 0% load	0.2	1.5	mA

Output Specifications

Parameters	Conditions	Typical	Maximum	Units
Voltage accuracy	100% load	±2	±4	%
Short Circuit protection	Continuous			
Short circuit restart	Auto recovery			
Thermal shutdown	Internal IC junction	170		°C
Line voltage regulation	Vin=(LL-HL) at full load	±0.2	±0.4	%
Load voltage regulation	10-100% load	±0.4	±0.6	%
Temperature coefficient	-40°C to +85°C ambient	±0.02		%/°C
Ripple & Noise	20MHz Bandwidth, 10 – 100% load	50		mV p-p
Transient response deviation	Nom Vin, 25% load step change	55	250	mV
Transient recovery time		0.5	2	ms

General Specifications

Parameters	Conditions	Typical	Maximum	Units
Switching frequency	100% load	550	850	KHz
Operating temperature	With derating above 71°C	-40 to +85		°C
Storage temperature		-55 to +125		°C
Max Case temperature			100	°C
Cooling	Free air convection			
Humidity	Non condensing		95	%
Case material	Black flame retardant and heat resistant plastic (UL94V-0 rated)			
Weight	2			g
Dimensions (L x W x H)	0.46 x 0.30 x 0.40 inches 11.60 x 7.55 x 10.16 mm			
MTBF	>2 000 000 hrs (MIL-HDBK-217F, Ground Benign, t+=+25°C)			
Soldering Temperature	1.5 mm from case for 10 sec		260	°C

NOTE: All specifications in this datasheet are measured at an ambient temperature of 25°C, humidity<75%, nominal input voltage and at rated output load unless otherwise specified.

Safety Specifications

Parameters	
Approval	UL
Standards	IEC/UL 60950-1
	EN55022: 2006 + A1:2007, Class B (with recommended circuit)
	IEC61000-4-2 (ESD): Contact $\pm 4\text{KV}$, Perf. Criteria B
	IEC61000-4-3 (Radiation Immunity): 10V/m, Perf. Criteria A
	IEC61000-4-4 (EFT): $\pm 1\text{KV}$, Perf. Criteria B (with recommended circuit)
	IEC61000-4-6 (Conducted Disturbance Immunity): 3Vr.m.s, Perf. Criteria A
	IEC61000-4-29 (VDDSI): 0%-70%, Perf. Criteria B

Pin Out Specifications

Pin	Positive	Negative
1	+V Input	+V Input
2	Ground	-V Output
3	+V Output	Ground

Dimensions

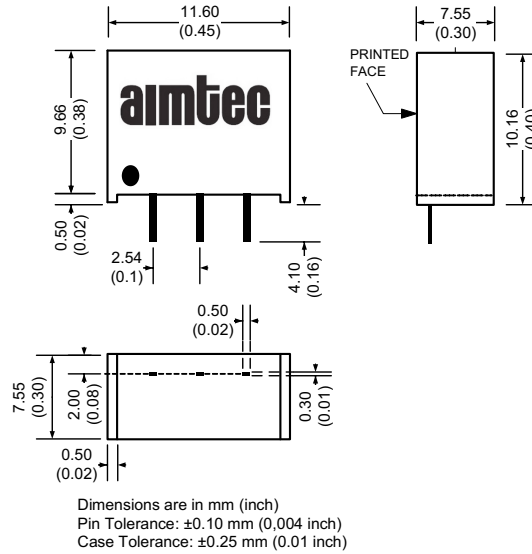

Derating

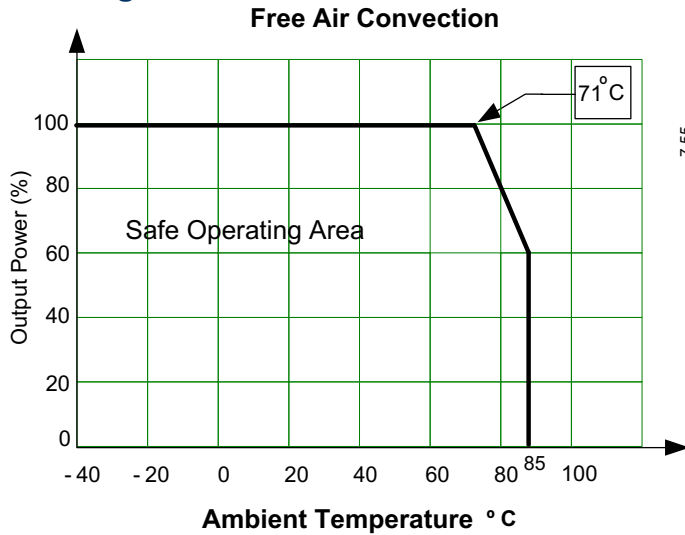

Standard Application circuit – positive output

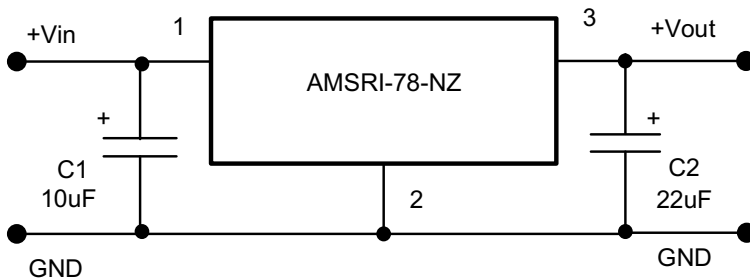

Standard Application circuit – negative output

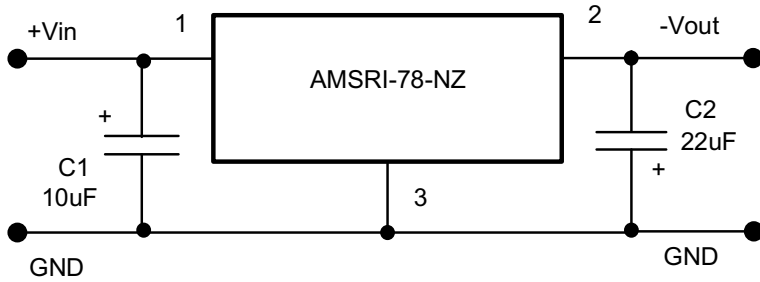

Ripple and Noise Reduction

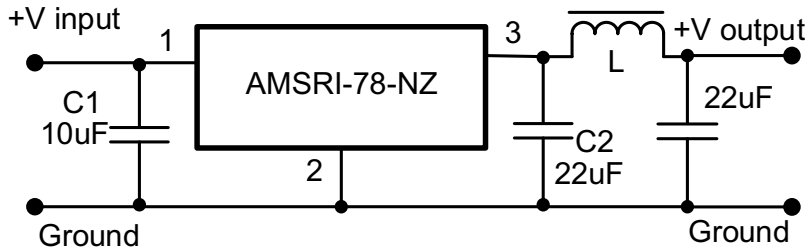

Recommended value of inductor L is between 10uH to 47uH

Recommended EMC circuit

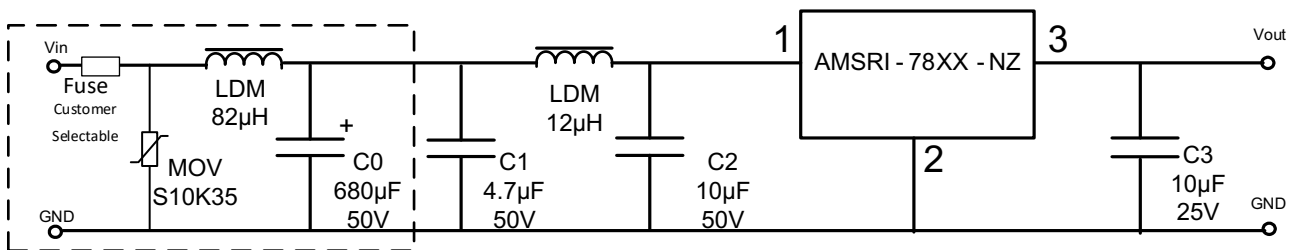

NOTE: This part is not designed for parallel operation, only input parallel supply to achieve positive and negative output

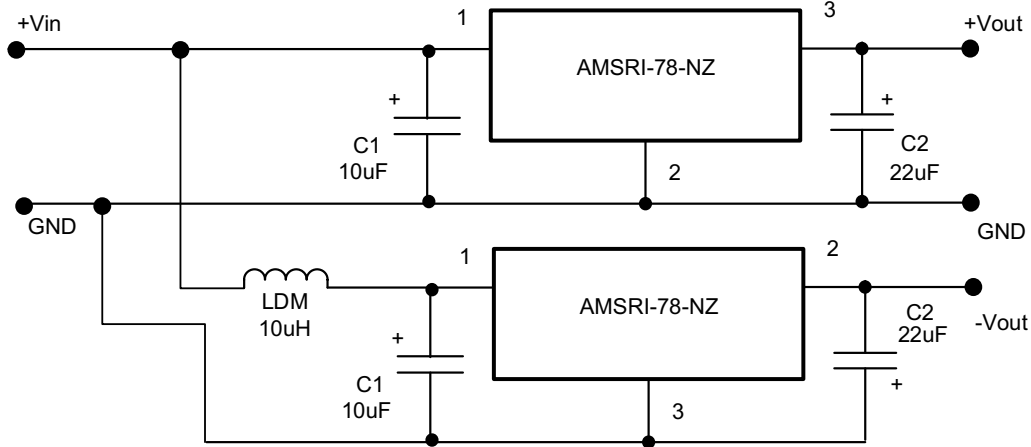

NOTE: 1. Datasheets are updated as needed and as such, specifications are subject to change without notice. Once printed or downloaded, datasheets are no longer controlled by Aimtec; refer to www.aimtec.com for the most current product specifications. 2. Product labels shown, including safety agency certifications on labels, may vary based on the date manufactured. 3. Mechanical drawings and specifications are for reference only. 4. All specifications are measured at an ambient temperature of 25°C, humidity < 75%, nominal input voltage and at rated output load unless otherwise specified. 5. Aimtec may not have conducted destructive testing or chemical analysis on all internal components and chemicals at the time of publishing this document. CAS numbers and other limited information are considered proprietary and may not be available for release. 6. This product is not designed for use in critical life support systems, equipment used in hazardous environments, nuclear control systems or other such applications which necessitate specific safety and regulatory standards other than the ones listed in this datasheet. 7. Warranty is in accordance with Aimtec's standard Terms of Sale available at www.aimtec.com.